



## 24" HORIZONTAL SLIDE OUTS P/N HSO-24 INSTALLATION INSTRUCTIONS

For additional assistance call (888)-514-0083 between 8AM-5PM EST or email: info@pactoolmounts.com

### CAUTION





To avoid the risk of personal injury, property damage or product damage, please use the included fasteners for mounting.

- \* This product must be securely mounted to a stable surface and material.
- \* Misuse of this product may result damage or injury and void warranty.
- \* Verify that all fasteners have been tightened securely before putting into service.
- \* CAUTION: Cut edges of aluminum extrusions may be sharp. Use care when handling or assembly.

 Tool Board materials and hardware are determined by size and/or customer specifications and therefore must be ordered separately. Illustrations shown may not be representative of quantity or size for every application.

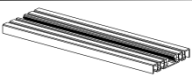
### STEP 1 – Assemble Board Sections to LH and RH Slide Assemblies

Align all sections of Dual Trac **P/N 7020** as shown. Position channel nuts **P/N 2023** into center grooves of board sections. Attach slide assemblies to sections button head screws **P/N 2060**. Check that the board is square and even before securing. Do not over tighten.

Items Required for this step	Qty
 P/N 7020 Pac Dual Trac	4 SECTIONS
 P/N HSO-24-903 24" Slide Assembly LH	1
 P/N HSO-24-901 24" Slide Assembly RH	1
 P/N 2060 1/4-20 x 3/4 B.H.C.S.	8
 P/N 2023 1/4-20 Channel Nut	8

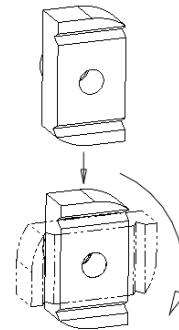

Push and Rotate  
P/N 2023 Channel Nut

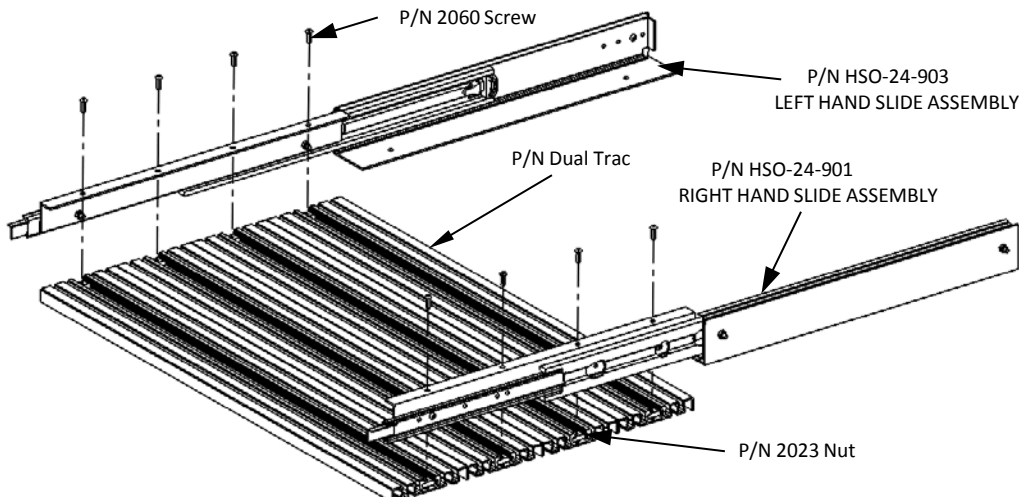

## STEP 2 – Attach Slideout to Mounting Surface

Attach the assembled slideout to the mounting surface with installer provided fasteners through the four mounting holes in the base of the slide mounting angles.

